



MRS1104C-011010

MRS1000

3D LIDAR SENSORS

SICK
Sensor Intelligence.



Ordering information

Type	Part no.
MRS1104C-011010	1075367

Other models and accessories → www.sick.com/MRS1000



Detailed technical data

Features

Measurement principle	HDDM ⁺
Application	Indoor
Light source	Infrared (850 nm)
Laser class	1 (IEC 60825-1:2014, EN 60825-1:2014)
Aperture angle	Horizontal 275° Vertical 7.5° (Over 4 scan planes)
Scanning frequency	50 Hz, 4 x 12.5 Hz
Angular resolution	0.25° 0.125°, interlaced 0.0625°, interlaced
Heating	Self-heating
Working range	0.2 m ... 64 m
Scanning range	At 10% remission 16 m At 90% remission 30 m
Spot size	10.4 mrad x 8.7 mrad
Amount of evaluated echoes	3

Mechanics/electronics

Connection type	M12 round connectors with swivel connector
Supply voltage	10 V DC ... 30 V DC
Power consumption	37 W, typ. 13 W, Start-up phase max. 30 W for 1 s
Housing	AlSi12, optics cover: PC
Housing color	Light blue (RAL 5012)
Enclosure rating	IP65 (IEC 60529:1989+AMD1:1999+AMD2:2013)
Protection class	III (IEC 61140:2016-11)
Electrical safety	IEC 61010-1:2010-06
Weight	1.2 kg
Dimensions (L x W x H)	151.9 mm x 150 mm x 92.5 mm

Performance

Scan/frame rate	55,000 measurement point/s ... 165,000 measurement point/s
Response time	4 layers, typ. 20 ms ¹⁾ 1 layer, typ. 80 ms
Systematic error	± 60 mm
Statistical error	≤ 30 mm
Integrated application	Integrated field evaluation with flexible fields on 4 levels, Data output
Number of field sets	Up to 64 fields
Simultaneous evaluation cases	Up to 16 evaluations
Filter	Fog filter Particle filter Average filter Median filter Ground reference evaluation Edge filter

¹⁾ Depending on the selected filter settings and the object size.

Interfaces

Ethernet	✓, TCP/IP, UDP/IP
Function	Host, OPC, NTP, Measured data output (distance, RSSI)
Data transmission rate	10/100 MBit/s
Digital inputs/outputs	I/O (8 (Multiport))
Output data	Contamination indication IMU (secondary sensor data)
Optical indicators	2 LEDs
Configuration software	SOPAS ET Web server (display)

Ambient data

Object remission	2 % ... > 1,000 % (Reflector)
Electromagnetic compatibility (EMC)	EN 61000-6-2:2005 EN 61000-6-3:2007+A1:2011
Vibration resistance	IEC 60068-2-6:2007
Shock resistance	EN 60068-2-27:2008
Ambient operating temperature	-10 °C ... +50 °C
Storage temperature	-40 °C ... +75 °C
Ambient light immunity	80 klx

General notes

Note on use	The sensor does not constitute a safety component as defined by relevant legislation on machine safety.
--------------------	---

Classifications

ECl@ss 5.0	27270990
ECl@ss 5.1.4	27270990
ECl@ss 6.0	27270913
ECl@ss 6.2	27270913
ECl@ss 7.0	27270913
ECl@ss 8.0	27270913

ECl@ss 8.1	27270913
ECl@ss 9.0	27270913
ECl@ss 10.0	27270913
ECl@ss 11.0	27270913
ETIM 5.0	EC002550
ETIM 6.0	EC002550
ETIM 7.0	EC002550
UNSPSC 16.0901	46171620

Dimensional drawing (Dimensions in mm (inch))

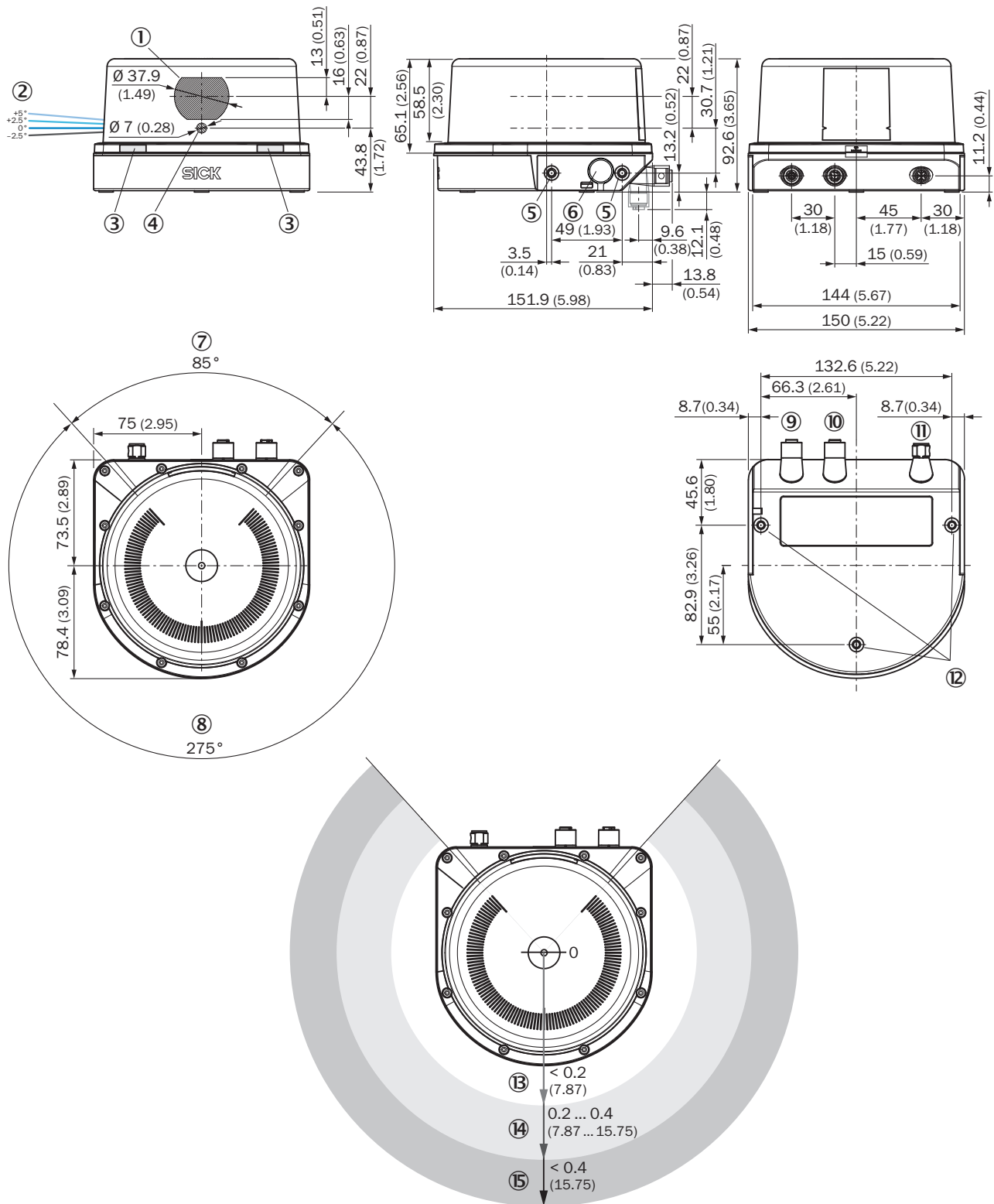

- ① Receiver
- ② Laser aperture angle, layers 1 to 4
- ③ Status LEDs
- ④ Sender
- ⑤ Mounting hole M5 x 7.5
- ⑥ Pressure compensation element

- ⑦ Blind zone
- ⑧ Field of view
- ⑨ Ethernet connection
- ⑩ I/O connection
- ⑪ POWER connection
- ⑫ Mounting hole M5 x 7,5
- ⑬ Close range (no detection or measurement possible)
- ⑭ Detection zone
- ⑮ Measuring range

Working range diagram

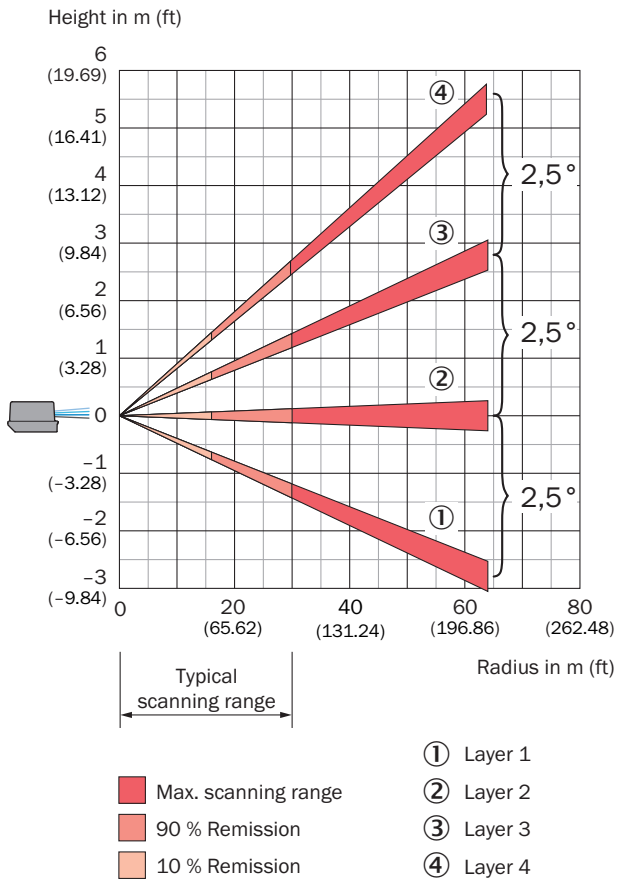

Scanning range in m

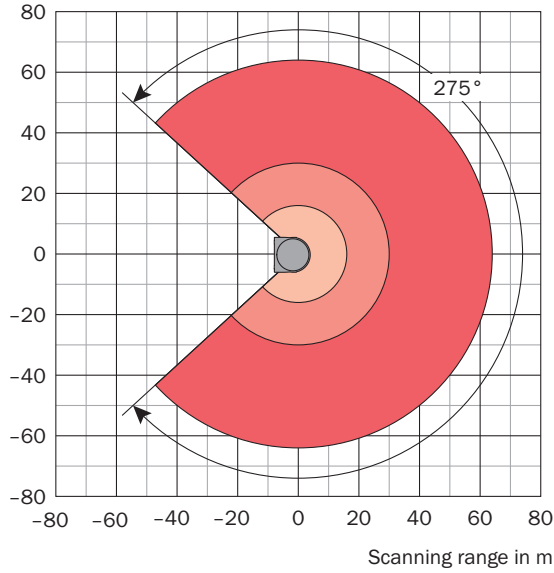

- Scanning range max. 64 m
- Scanning range for objects up to 90 % remission 30 m
- Scanning range for objects up to 10 % Remission 16 m

Connection type

Ethernet

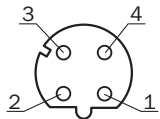

M12 female connector, 4-pin, D-coded

- ① TX+
- ② RX+
- ③ TX-
- ④ RX-

I/O

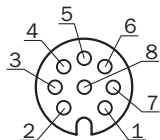

Connector M12, 8-pin, A-coded

- ① IN1/OUT1
- ② IN2/OUT2
- ③ IN3/OUT3
- ④ IN4/OUT4
- ⑤ IN5/OUT5
- ⑥ IN6/OUT6
- ⑦ GND IN_x/OUT_x
- ⑧ IN7/OUT7

Power

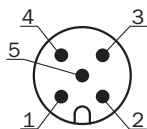





Connector M12, 5-pin, A-coded

- ① VS 10...30 V
- ② Reserved
- ③ GND
- ④ IN8/OUT8
- ⑤ Reserved

Recommended accessories

Other models and accessories → www.sick.com/MRS1000

	Brief description	Type	Part no.
Terminal and alignment brackets			
	Easy Mount, X6CRNIT1810 (1.4541)	Mounting kit	2093194
Plug connectors and cables			
	Head A: female connector, M12, 5-pin, straight, A-coded Head B: Flying leads Cable: Sensor/actuator cable, PUR, halogen-free, shielded, 5 m	YF2A25-050UB6XLEAX	2095733
	Head A: male connector, M12, 8-pin, straight, A-coded Head B: Flying leads Cable: Sensor/actuator cable, PUR, halogen-free, shielded, 5 m	YM2A28-050UA6XLEAX	6036155
	Head A: male connector, M12, 4-pin, straight, D-coded Head B: male connector, RJ45, 4-pin, straight Cable: Ethernet, PROFINET, PUR, halogen-free, shielded, 5 m	YM2D24-050PN1MRJA4	2106184

Recommended services

Additional services → www.sick.com/MRS1000

	Type	Part no.
Product, system, and software training		
<ul style="list-style-type: none"> • Range of services: The training contents relate to the following 2D and 3D LiDAR sensors: LMS series, MRS1000, MRS6000, NAV series or TiM series, Training format and location can be worked out in collaboration with SICK 	Training LMS/MRS/NAV/TiM	1612234
Warranty extensions		
<ul style="list-style-type: none"> • Product area: Identification solutions, machine vision, Distance sensors, Detection and ranging solutions • Range of services: The services correspond to the scope of the statutory manufacturer warranty (SICK general terms and conditions of purchase) • Duration: Five-year warranty from delivery date. 	Extended warranty for a total of five years from delivery date	1680671

	Type	Part no.
Commissioning		
<ul style="list-style-type: none"> • Product area: 2D LiDAR sensors, 3D LiDAR sensors • Range of services: Inspection of connection, fine adjustment, configuration of monitored areas, configuration and optimization of parameters of the LMS/MRS/NAV/TiM as well as tests, Setup of previously defined functions of basic settings, parameters of field application, filters for raw data output and product-specific configuration • Travel expenses: The prices do not include travel costs such as hotel, flight, travel time and expenses. • Duration: Additional work will be invoiced separately 	Commissioning LMS/ MRS/NAV/TiM/People Counter (Prime package)	1680672
Maintenance		
<ul style="list-style-type: none"> • Product area: 2D LiDAR sensors, 3D LiDAR sensors • Range of services: Inspection, analysis and restoring of defined functions, Inspection and adaptation of basic settings, parameters of field application, filters for raw data output, and product-specific configuration • Travel expenses: The prices do not include travel costs such as hotel, flight, travel time and expenses. • Duration: Additional work will be invoiced separately 	Maintenance LMS/ MRS/NAV/TiM	1682593

SICK AT A GLANCE

SICK is one of the leading manufacturers of intelligent sensors and sensor solutions for industrial applications. A unique range of products and services creates the perfect basis for controlling processes securely and efficiently, protecting individuals from accidents and preventing damage to the environment.

We have extensive experience in a wide range of industries and understand their processes and requirements. With intelligent sensors, we can deliver exactly what our customers need. In application centers in Europe, Asia and North America, system solutions are tested and optimized in accordance with customer specifications. All this makes us a reliable supplier and development partner.

Comprehensive services complete our offering: SICK LifeTime Services provide support throughout the machine life cycle and ensure safety and productivity.

For us, that is “Sensor Intelligence.”

WORLDWIDE PRESENCE:

Contacts and other locations –www.sick.com